

Using Different Types of Moment Resistant Steels to Develop Lightweight Cold Formed Steel Structures with Improved Seismic Performance Assembled using steel

M.Shankara Rao, KORLA CHANDANA,B PRUDHVI RANI

Assistant professor,
Department of Civil Engineering,
Visakha Institute of Engineering & Technology,
Division,GVMC,Narava, Visakhapatham, Andhra Pradesh.

Abstract:

Because of its tremendous strength and ductility, structural steel offers several benefits over other building materials. When compared to concrete, it has a greater strength to cost ratio in tension but a slightly lower strength to cost ratio in compression. We will use moment-resistant connections such as stiffened, un-stiffened, and splices to experimentally test the beam column rolled and cold-formed steel connection in this study. To save money while still getting the highest seismic performance, different cross-sectional shapes and a variety of connections are now being employed in the majority of nations. Cold-formed steel sections with varied moment resistance connections were studied for their earthquake performance. Compared to other forms of connections, splice connections have the best moment resistance connection, seismic resistance of buildings, high load bearing ability, and minimal weight, according to the final report's findings. Because of the great load bearing capability of the splice connection, we are able to lower the section size and thereby avoid the base shear. A splice connection made of cold formed steel, a strengthened connection, and a deflection of the load

INTRODUCTION

A moment-resisting connection is utilised in multi-story unbraced structures and one-story portal frame constructions. JEROME F. (etal). In multi-story frames, bolted, full-depth end plate connections or extended end plate connections are the most common methods of connecting the end plates. A hunched connection may be employed if a deeper connection is needed to offer a bigger lever-arm for the bolts. This circumstance, however, should be avoided if at all feasible due to the additional fabrication it would need. Almost often, in portal frame constructions, hunched moment resistant connections are employed at the eaves and apex of a frame since the haunch boosts the rafter's resistance in addition to giving greater connection resistances Designing a stiffening connection for seismic-resistant web yielding and local flange bending was also addressed in the article. Seyed Mohammad Mojtabaei (etal) showed that local buckling of cold formed steel beam sections at the first row of bolts was the primary failure mechanism for bolted moment connections made of cold formed steel. When the flange channels are bent and folded, arching action may be used to provide stiffness in plane and move the local buckling to web, delaying local buckling. Only a 10% increase in moment capacity is possible when employing bent flange channels (folded and curved). Square bolt connections have a 32% greater maximum moment capacity than other types of connections, while the narrowness ratio has improved by roughly 55%, with

higher ductility levels of 45%, 30%, and 40%, respectively, when compared to the curvature of the fat and stiffening of the fat. a bolt connection with a diamond- or circular-shaped bolt arrangement that has a high degree of ductility. M. Dundu (et al.) reported that the cold formed steel sections and hot rolled angle section. Buckling in cold produced channels sections and bearing distortion in the substantially loaded flange were found. A simple connection may be made using bolted angle cleats. There are now a number of new methods for constructing steel buildings that are resistant to earthquakes. The splice connection, which was recently invented, is the best method for controlling vibration forces in steel buildings that are subject to cyclic loads and seismic resistance. Experimentation and theoretical inquiry led to the development of a cold formed section with an experimental and theoretical relationship, according to A Jayaraman (et al). In this document. Both the spliced and non-spliced cold formed steel sections, ISMC 100 mm for 1m length and 0.5 m length, have a lower load-carrying capacity than the standard steel section, which is 55.55% and 46.67% respectively. 75 mm in ISMC for 1 metre and 0.5 metre lengths, respectively,

Development of Light Weight and Seismic Performance of Light Gauge Cold Formed Steel Structures by Different Types of Moment Resistant Steel Connection

Compared to conventional steel sections, the load bearing capacity of cold formed steel sections is 42.85%, 55.7%, and 77.77% lower; it is also 68.08 and 49.10 percent smaller. Cold-formed steel section deflection is 53.70 percent and 52.94 percent less than conventional steel section ISMC100 mm and ISMC 75 mm when connected with and without splice connection. With and without splice connections, the total member weight and the overall weight of structures are 66%, 70%, 88%, and 88% lower in the cold formed steel section than the traditional steel section. When using cold-formed steel sections, the overall cost is estimated to be 88% cheaper than when using standard steel sections, whether the connection is made with or without a splice. For both spliced and non-spliced connections, the base shear in cold formed steel section is much lower than in traditional steel section. It was found that the load-carrying capacity of cold formed steel sections with single and multiple bolted connections may be increased by infilling various grades of conventional concrete and Geopolymer concrete. 8.95 to 57.25 percent improvement in the ultimate load bearing capability of the bolted connection. Filling the joints with conventional or geopolymer concrete. Almost same results are obtained when joints are filled with geopolymer concrete or ordinary concrete. The moment resistance of cold formed steel sections ranges from 36% to 97% when tested by bolted moment connections. M F Wonlf further refined the back-to-back connection of cold-formed steel channel sections employing medium and large span constructions. Bracing systems in steel buildings were previously examined by K.K Sangle (et al.) and shown to reduce lateral displacement at the roof level, which is important for controlling seismic behaviour and controlling system vibration. The roof level bracing system's displacement is decreased by 43 percent to 60 percent, and the time period is also reduced by up to 65 percent. The f bracing system's efficient and cost-effective design was achieved by using a diagonal B-style bracing system. During the last decade, the use of cold-formed steel (CFS) structural parts has grown dramatically. Structural, mechanical, and aeronautical engineers now employ CFS systems. Aside from being lighter in weight and more convenient to assemble, CFS members are more cost-effective and versatile than hot-rolled competitors. Although CFS structural parts have a relatively low buckling resistance because to their thin sections, they may not be able to withstand high

stress events such as powerful earthquakes. There has been a lot of research on the seismic performance of CFS buildings, however the bulk of these studies have focused on how shear wall panels perform. However, the use of moment resistant CFS frames may eliminate the need for permanent shear wall panels and therefore provide flexibility for space design and future adjustments.

AIM OF THE PROJECT

Development of low weight and seismic performance of light gauge cold formed steel structures is the primary goal of this research.

CONNECTION DETAILS

Using cold-formed light gauge steel in un-, strengthened, and spliced connections to create lightweight structures. Light-gauge cold-formed steel may be used to build earthquake-resistant buildings that are neither stiffened or spliced. By using light gauge cold formed steel that has not been stiffened, stiffened, or spliced, the constructions are low in cost and cheap. Cold rolled portions provide a number of benefits over hot-rolled sections, including the following: Cross-sectional forms are limited to a few options and may be repeated for as long as necessary. Using cold rolling, any desired form may be passed on to the desired length. High levels of protection against usage may be achieved by forming pre-blened or pre-anchored metals that have been pre-coated or pre-anchored. They are easy to move and erect because to their modest weight.

Splice connection

This junction is utilised when the length of the material being connected does not match. Other joints, such as the butt and scarf joints, may be substituted.

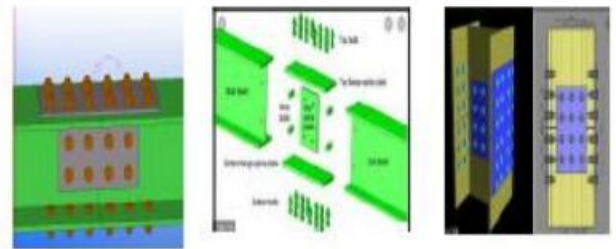

Figure 1. Splice connection



Figure 1(a). Experimental set up for loading of rolled steel bolted splice connection



Figure 2 (b)
Experimental set up
Un stiffened seat
angle bolted
connection

Figure 2 (c)
Experimental set up
Un stiffened seat
angle welded
connection

It is termed an un-stiffened seat connection when a horizontal angle with a horizontal leg at its top is utilised to accept a beam.

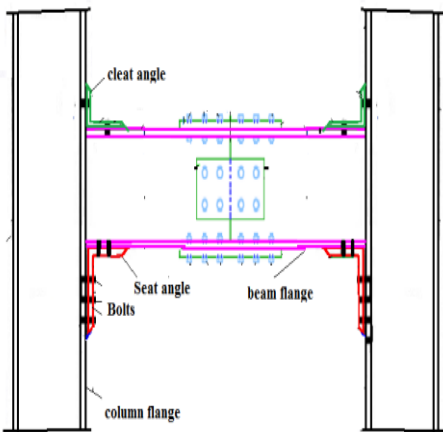
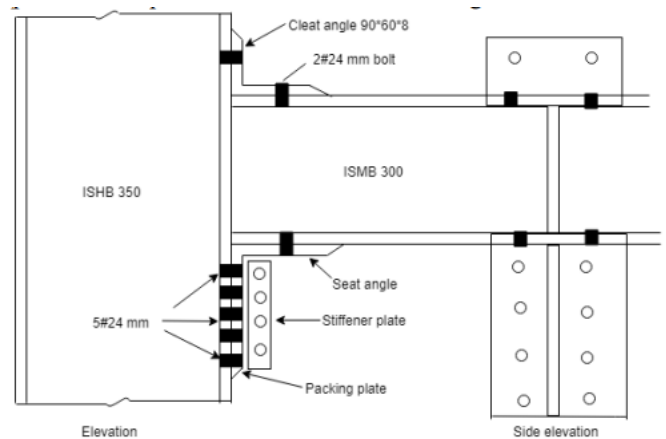
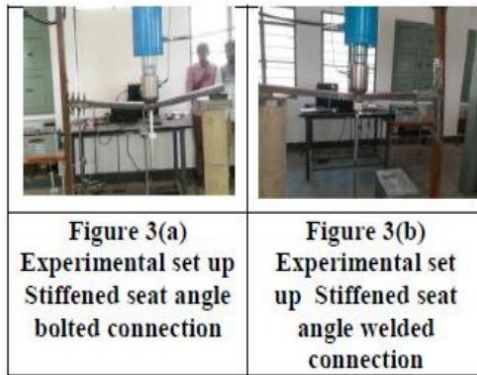

Figure 2. Un stiffened connection

Stiffened Seat Connections

Besides the angle of the seat, there is also a web cleat and a flange cleat utilised when the beam is attached to a beam and the stanchion. The angle cleats are necessary to maintain the beam vertical and prevent it from buckling in the other direction.





EXPERIMENTAL PROCEDURE

Moment-resistant connections of conventional steel and cold-formed steel structures will be studied in this study employing stiffened, un-stiffed and spliced connections. Because of this, splices are often utilised in structural parts that must be longer and more resistant to seismic forces. As per codal requirements, moment-resistant connections for both conventional and cold formed steel have been experimentally tested. Look at the rolled steel channels section and the cold formed steel section ISMC100 and ISMC75. ISMC100, ISMC75, and a length of 1m, 1.5m, and 2m, respectively, are measured. Splice plates are used to link the appropriate portions, which are reduced to 0.5m in length. An automated universal testing machine with a capacity of 1000kN is used for the testing. Steel sections that have an ordinary or moment-resistant connection are tested for their load-carrying and deflection capability; sections made of rolled steel and cold forming are also tested.

RESULTS AND DISCUSSION

load carrying capacity of bolted and welded connections

Table 1. Load carrying capacity bolted connections

S.N	Load Carrying Capacity of Steel section		
	Different types of Bolted Connection	Rolled Section	Cold Formed Steel Section
1	Ordinary	3.8	3.0
2	Un stiffened	8.5	9.7
3	Stiffened	8.3	9.7
4	Splice connection	10.6	11.5

Structures Using Different Moment Resistant Steel Connections for Light Gauge Cold Formed Steel Development

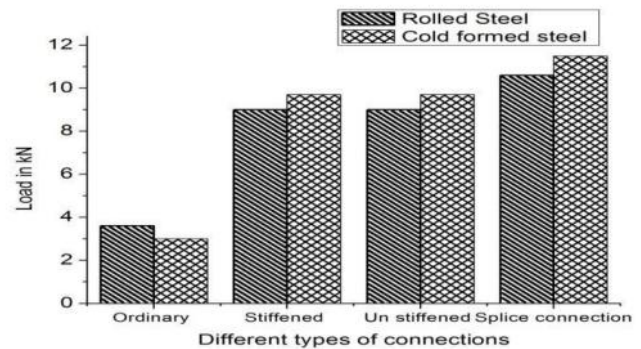

Load carrying capacity bolted connections

Load-carrying capacity of rolled steel un-stiffened, stiffened, and spliced bolted connections were found to be 55.29%, 54.21%, and 64.15% higher than that of a conventional bolted connection after an experimental examination. Tests show that the load-carrying capacity of cold formed steel spliced bolted connections is raised by 69%, 69%, and 73% when compared to regular bolted connections based on experimental results. For rolled steel, it was determined to be 14.11 percent unstiffened, 16.86 percent spliced, and 8.490 percent stiffened in an experimental research. Cold-formed steel sections have a lower load-carrying capability than conventional connections. In most cases, the load-

carrying capability of rolled steel and cold formed steel sections is comparable.

Load Carrying Capacity of welded Steel section

S.No	Load Carrying Capacity of welded Steel section		
	Different types of Welded Connection	Rolled Section	Cold Formed Steel Section
1	Ordinary	9.12	4.35
2	Un stiffened	11	11.5
3	Stiffened	8	8
4	Splice connection	12.13	13.8

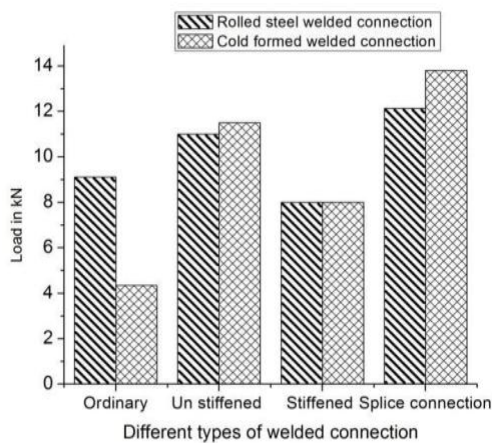

Load carrying capacity welded connections

Splice welded connections are shown to be 11 percent stiffer than welded un-stiffened rolling steel connections in testing studies. Compared to regular bolted connections, the stiffened welded connection has a higher load-carrying capacity and a 12.28 percent lower load-carrying capacity. Cold formed steel un-stiffened, stiffened, and spliced welded connections have a 62.17 percent, 45.62 percent, and 68.47 percent improvement in load-carrying capacity compared to regular welded connections, respectively. Rolled steel welded unstiffened and spliced connections were determined to be 4.34 percent and 10.86 percent respectively in experimental examinations. When compared to lighter cold formed steel sections, the load bearing capability is reduced. The stiffened welded

connection's load-carrying capability is comparable to that of the rolled steel and cold formed welded connections. When compared to light gauge cold formed steel section, the load bearing ability of ordinary welded rolled steel section is 52.30 percent higher. Bolted and welded connection weight of section 3.4.2

Weight of section in bolted connection

S.No	Weight of Steel section in kg		
	Different types of Bolted Connection	Rolled Section	Cold Formed Steel Section
1	Ordinary	26.38	21.86
2	Un stiffened	12.52	10.76
3	Stiffened	12.84	10.94
4	Splice connection	12.6	10.82

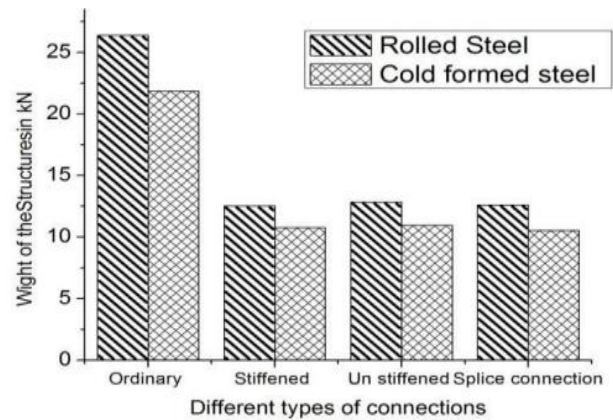

Weight of section in bolted connection

Weight of section in welded connection

S.No	Weight of Steel section		
	Different types of Welded Connection	Rolled Section	Cold Formed Steel Section
1	Ordinary	12.84	11
2	Un stiffened	11.84	9.5
3	Stiffened	12.05	9.7
4	Splice connection	10.61	9.1

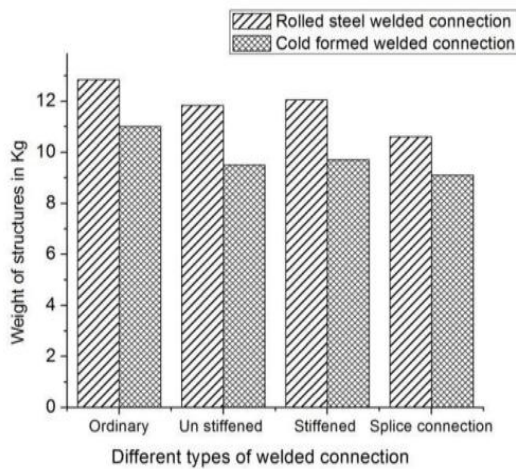

S.No	Base shear in kN		
	Different types of Bolted Connection	Rolled Section	Cold Formed Steel Section
1	Ordinary	3.2	2.95
2	Un stiffened	1.4	1.36
3	Stiffened	1.8	1.6
4	Splice connection	1.35	1.20

Weight of section in welded connection

It has been shown that the weight of unstiffened, stiffened and splice bolted and welded connections is 7.78 percent, 6.15 percent and 17.36 percent less than that of regular bolted and welded connections, respectively. Light gauge cold formed steel, un stiffened, stiffened & splice bolted and welded connections are found to be 50.77 percent, 49.95 percent & 50.50 percent and 42.68 percent, 70.35 percent & 79.32 percent lighter than regular bolted and welded connections. Weighing in at 17.13 percent, 14.05 percent, 14.79 percent, and 14.12 percent more than cold-formed steel, the weight of spliced bolted and welded connections of rolled steel is up to 19.76 percent, 19.50 percent, and 14.12 percent heavier than that of the cold-formed steel section. Bolt-and-weld connections are used for the base shear.

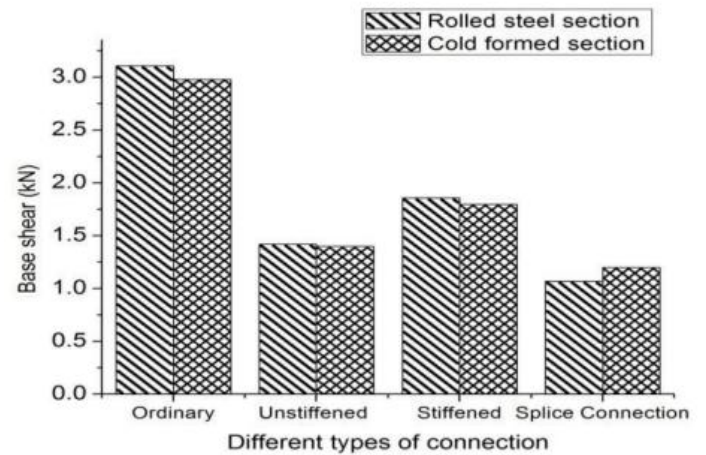

Base shear in bolted connection

Base shear in welded connection

Base shear in bolted connection

S.No	Base shear in kN		
	Different types of Welded Connection	Rolled Section	Cold Formed Steel Section
1	Ordinary	3.034	2.53
2	Un stiffened	1.92	1.45
3	Stiffened	1.175	0.75
4	Splice connection	1.034	0.523

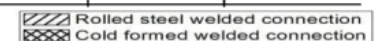

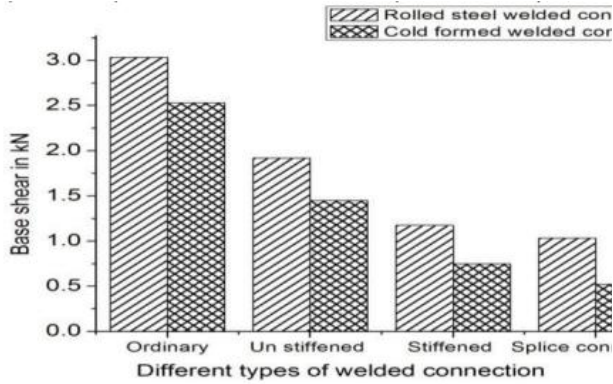

Base shear in welded connection

Unstiffened, stiffened, and spliced bolted and welded connections are found to be 56.25 percent, 43.75 percent, and 17.36 percent respectively, whereas welded connections are 53.89 percent, 45.76 percent, and 59.32 percent respectively. Base shear is found to be reduced when compared to conventional bolted and welded connections. An experimental research of light gauge cold formed steel indicated that the percentage of unstiffened, stiffened, and splice bolted and welded connections is 50%, 49.95%, and 50%, as well as 42.68 percent, 70.35 percent, and 79.32 percent. When compared to conventional bolted and welded connections, the structure seems to be lightest in weight. Bolted and welded connections of all kinds of rolled steel have lower base shear than cold-formed steel sections by 7.813%, 2.857%, 11.11% and 11.11 and 16.613%, 24.47%, 36.170% and 49.413% when compared to cold-formed steel sections. This is true for all types of bolted and welded connections.

Weight Reduction through Seismic Development In terms of performance, Light Gauge is the best. Various Moment Resistant Steel Connections for Cold Formed Steel Structures Welded and bolted connection deflection In a bolted connection,

S.No	Deflection in mm		
	Different types of Welded Connection	Rolled Section	Cold Formed Steel Section
1	Ordinary	38	41
2	Un stiffened	35	34
3	Stiffened	30	42
4	Splice connection	21	33

For rolled steel bolted connections, the deflection capacity is 13.51 percent, 18.75 percent, and 17.30 percent, respectively, compared to cold formed steel sections and standard rolled steel bolted connections, which have 13.46 percent deflection capacity, according to the results of an experiment.



In a bolted connection,

Welded connections may deflect.

S.No	Deflection in mm		
	Different types of Welded Connection	Rolled Section	Cold Formed Steel Section
1	Ordinary	38	41
2	Un stiffened	35	34
3	Stiffened	30	42
4	Splice connection	21	33

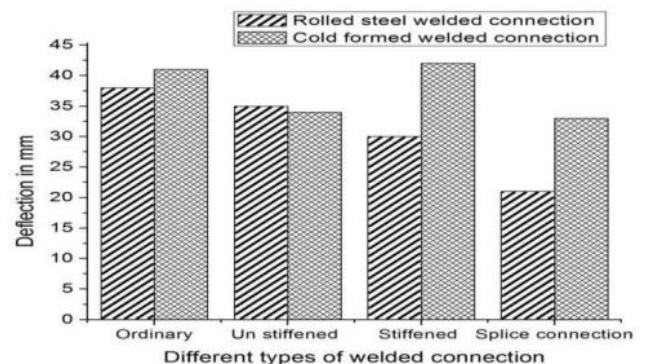

Figure 11. Deflection in welded connection

It is discovered to be 7.29 percent, 21.05 percent, and 44.73 percent by the experimental research of rolling steel, unstiffened, stiffened, and splice welded

connection. It has been shown that the deflection of the bolted connection is significantly reduced. Cold formed steel, unstiffened and spliced welded connections are discovered to be 17.07 percent and 19.51 percent respectively by experimental study. When compared to a conventional bolted connection, the amount of deflection is shown to be much lower in a strengthened welded connection, as well. Compared to cold formed steel sections in conventional connection, strengthened and spliced welded connection, the deflection is 7.89 percent, 28.57 percent, and 36.36 percent higher. In a strengthened welded connection, the deflection of rolling steel and cold formed section is almost same.

CONCLUSIONS

Spliced, welded, and bolted unreinforced, stiffened, and spliced connections of low gauge cold formed steel section are used to create lightweight structures. Light gauge cold formed steel in both welded and bolted un stiffened, stiffened, and spliced connections may be used to build earthquake and seismic resistant buildings. Light gauge cold formed steel in both welded and bolted un-, stiffened-, and spliced connections provides the constructions with low costs, economic strength, and long-term durability. In both the rolled and cold formed sections, welded connections have a higher load-carrying capability than bolted connections. In both welded and bolted connections, the splice connection's load-carrying capability is superior to that of stiffened and un-stiffened connections. Additionally, a splice connection with high load-carrying ability may lower the section size and minimise base shear because of reduced weight of structures, as claimed in claim 5. There is a splice in the connection best seismic performance in→ both cold formed steel and rolled steel section compare with other types of connections.

REFERENCE

1. S. K. Duggal” Limit State Design of Steel Structures “
2. N. Subramanian “Design of Steel Structures based on Limit state Method of design as per standardized code IS: 800: 2007.
3. S.S Bhavikatti “Design of steel structure by limit state method as per IS: 800: 2007”.

4. IS: 801:1975 Code of Practice for Use of Cold Formed Light Gauge Steel Structural Members in General Building Construction.

5. IS 811: 1987 Specification for Cold Formed Light Gauge Structural Steel Section.

5. IS 800 Code of Practice for General Construction in Steel , Bureau of Indian Standards, New Delhi ,2007

6. IS 1893 -2002 “ Criteria for Earthquake Resistance and Construction of Buildings”Bureau of Indian Standards, New Delhi

7. A Jayaraman (etal) “Seismic Performance of Cold Formed Steel and Conventional Steel of Industrial Structures Using Splice Connections” International Journal of Recent Technology and Engineering” ISSN: 2277-3878, Volume-7 Issue-4S2, December 2018.

8. JEROME F (etal) “Continuity Plate Detailing for Steel MomentResisting Connections” ENGINEERING JOURNAL”, September2003