

Re hability Of RC Homes The Use Of Structural Partitions

Mrs.B. Sahithi Chandra¹, Mrs. Peesapati Saileela Vaishnavi², Mr. BajibabuPagidi³

^{1,3} Assistant Professor, Associate Professor²,
^{1,2,3} Department of Civil Engineering,
^{1,2,3} Global Institute of Engineering & Technology, Moinabad, Rangareddy Dist., Telangana State.

Abstracts:

A evolved macroscopic model is applied to the evaluation of an example structure to demonstrate the use and blessings of the version. The lateral potential of a three storeys reinforced concrete (RC) constructing earlier than and after rehabilitation become assessed the use of pushover analysis and nonlinear dynamic analysis. The nonlinear dynamic time history analysis became performed the use of El Centro document at some point of the Imperial Valley earthquake scaled to one of a kind peak ground accelerations (PGA). A rehabilitation approach the use of structural walls become designed and tested the usage of pushover analysis and nonlinear dynamic evaluation with the El Centro file as the ground motion time history input.

INTRODUCTION

The lateral resistance of multistorey reinforced concrete frame structures, designed before the availability of current seismic design codes, may not be adequate. In addition, buildings designed to low levels of seismic loads according to older codes that have since been upgraded, may also be deficient. The use of nonductile detailing in these codes results in low seismic capacity. One of the major challenges that faces structural engineers is how to determine the seismic capacity of these buildings and decide if they need rehabilitation or not and which rehabilitation technique to be used. One of the most common rehabilitation techniques is to provide additional reinforced concrete structural walls. The resisting mechanism of reinforced concrete shear panel is diagonal compression of the infilled concrete. Therefore the initial stiffness and ultimate resistance are high. However, deformability is small because of compression fracture of concrete. In the past decade, existing RC buildings received attention by researchers. A number of experimental and analytical studies were conducted to gain better understanding of the behaviour of these buildings. However, on the analytical side, models to represent existing structures are still in the process of improvement.

To determine the seismic capacity of existing buildings and analyse existing buildings after rehabilitation using structural walls, accurate, simple and practical models should be developed. The availability of such models allows the assessment of the seismic performance of existing structures which is necessary information for the development of rehabilitation codes. A representative model should contain the main characteristics that describe completely the hysteretic behaviour of reinforced concrete structural components. These characteristics include stiffness degradation, strength softening and pinching behaviour. In addition, the used model should be as simple as possible so that the analysis can be performed with reasonable computational effort, especially in the case of multistorey structural systems. Available models for representing RC structures are concerned only with the maximum load carrying capacity. Available models are mostly unable to predict the post peak strength response and most importantly the failure mechanism. Some researchers (Abouelfath, 1999; park et al., 1987) predicted the post peak response by using parameters that was calibrated using the available experimental results. Other researchers (Miramontes et al., 1996; Chung et al., 1989) used damage indices to define the degrading slope. These methods are doubtful as it might be correct for certain cases but can not be generalized. The model adopted for the analysis of reinforced concrete elements should be capable of simulating the behaviour due to different failure modes.

BUILDING DESCRIPTION

A three-storey reinforced concrete office building was designed to represent existing nonductile buildings. The building consists of three bays by five bays. Each bay is 6 m wide. The floor height is 3.6 m. The total dead weight of the building is 7000 kN. The building was designed for gravity loads only according to the 1963 ACI code (ACI 318-63). The concrete strength is 21 MPa and the steel yield strength is 300 MPa. All beams are 250x600 mm, exterior columns are 300x300 mm and interior columns are 400x400 mm. Typical floor plan of the existing office building is shown in figure 1.

Nonductile reinforcement details in the building, as shown in figure 2, include: beam bottom longitudinal reinforcement embedded 150 mm into the beam-column joint, widely spaced transverse reinforcement in beams and columns (M10 at 300 mm), column lap splices (20 bar diameter) located just above the floor level and no transverse reinforcement in the joints.

PROPOSED REHABILITATION SYSTEM

The seismic design load for the building was calculated assuming that the building is located in the city of Victoria, British Columbia. The force modification factor, R, was taken equal to two assuming that the building resisting system is RC walls with nominal ductility. Walls were not assumed ductile to limit the damage in the original structure as it has very limited ductility. The system of walls used for the rehabilitation process is shown in figure 1. Including the effect of torsion due to incidental eccentricity, the total base shear to be carried by an exterior wall is calculated to be equal to 0.14 of the total weight of the building.

The wall thickness is taken 200 mm and assuming that the original columns are acting with the wall as a boundary element, the wall reinforcement was calculated according to CSA Standard (A23.3-94, 1994) and is shown in figure 3. Sufficient dowels calculated to resist the shear flow are to connect the wall with the columns.

MODEL DESCRIPTION

The developed model (Youssef and Ghobarah, 1999; Ghobarah and Youssef, 1999, Youssef and Ghobarah, 1998) is a macro model that accounts for beam-column joint shear deformations. Each member is represented using an elastic element and two inelastic elements. Each inelastic element consists of three concrete springs and three steel springs. The beam-column joint shear deformation is idealized using shear springs. The model is capable of idealizing the component failure due to cumulative concrete crushing, bond slip or beam-column joint shear failure. The developed model was verified using test results on specimens representing existing structures. The computer model used for analyzing the existing building before and after rehabilitation is shown in figure 4.

PUSHOVER ANALYSIS

The purpose of the nonlinear pushover analysis was to identify the lateral strength of the structure and its behaviour under static load. The three-storey frame was subjected to an increasing monotonic lateral load of an inverted triangular distribution. The lateral load was distributed over the height of the building as shown in figure 5.

Overall displacement and drift

Figure 6 shows the applied load-roof drift relationships. The lateral strength of the existing frame is 250 kN and that of the rehabilitated frame is 1500 kN. Knowing that the existing building consists of six frames, the existing building lateral strength is 1500 kN. The rehabilitated building lateral resistance is 6000 kN as the lateral load resisting system was assumed to be four RC walls. The rehabilitation system resulted in increasing the initial stiffness and increasing the lateral strength of the building by about 4 times.

Figures 7 shows the distribution of storey drifts and interstorey drifts along the height of the building for both the existing and rehabilitated frames. For the existing frame, the interstorey drift in the first two floors is much higher than the third floor. This means that damage is mainly concentrated in the first two floors. For the rehabilitated frame, the interstorey drift in the three floors is nearly equal which implies that the rehabilitation system is effective in distributing the damage along the building height.

Failure mechanisms

Several investigations have been conducted on the modeling and behaviour of reinforced concrete (RC) buildings. However, the definition of failure is still a deficiency in most available models. Near collapse, it is often difficult to distinguish between numerical instability and structural instability (Ghobarah, 1998). In frame analysis, failure is defined by most researchers as steel yielding. On the basis of this concept, plastic hinge distribution is defined. This is a crude assumption as concrete sections can carry loads after steel yielding. Failure is defined in this research work as the point at which strength degradation starts. By this definition, bond slip failure can be detected from the steel springs, cumulative concrete crushing from the concrete springs and shear failure from the shear springs.

Figure 8 shows the failure mechanism for the existing frame. The failure in the frame is mostly concentrated in the columns. Bond slip softening is concentrated in the columns despite the fact that beam lap splices are shorter than column lap splices. This is because flexural capacities of the beams are higher than those of the columns and the frame is essentially of strong beam-weak column design. Failure in beams was limited to those beams connecting to exterior columns due to the high demands on those beams relative to the interior ones. The first two floors suffered much more than the third floor which was detected in the previous section from the interstorey drift diagram. At the end of loading, failure occurred due to the soft first storey.

Figure 8 also shows the failure mechanism for the rehabilitated frame. The failure is distributed between beams, columns and the added structural wall. Same conclusion was reached in the previous section from the interstorey drift diagram. At the end of loading, failure occurred due to the soft first storey.

DYNAMIC ANALYSIS

This section describes the response of the three-storey frame structure to earthquake excitation. The masses are assumed to be lumped at the beam column-joints. The dynamic analysis of the building when subjected to earthquake ground motion is carried out by solving the equation of motion using step by step integration procedure. Integration time step of 0.005 second was found to produce accurate results. The acceleration time history selected as input ground motion is El Centro record (component S00E), Imperial Valley earthquake, California, 1971 with PGA of 0.348g and PGV of 0.334 m/s.

Roof displacement time histories

Figure 9a shows the roof displacement time histories for the existing frame subjected to El Centro record scaled to PGA of 0.10g, 0.15g and 0.20g. When the record scaled to PGA of 0.20g is used as input ground motion, failure of the building occurred 13.02 seconds into the earthquake record. The maximum roof displacements were 32.58 mm (0.30% drift), 42.84 mm (0.40% drift) and 57.83 mm (0.54% drift) for peak ground accelerations of 0.10g, 0.15g and 0.20g, respectively.

By comparing the maximum roof drift with the drift obtained from the pushover curve shown in figure 6, it is found that under the effect of earthquake loading, the building behaved with very limited ductility as brittle failure occurred when the peak strength was achieved.

Figure 9b shows the roof displacement time histories for the rehabilitated frame when subjected to the El Centro record scaled to PGA of 0.50g, 0.70g and 0.75g. When the record scaled to PGA of 0.75g is used as input ground motion, failure of the building occurred 0.301 seconds into the earthquake record. The maximum roof displacements were 3.61 mm (0.03% drift), 5.08 mm (0.05% drift) and 22.15 mm (0.21% drift) for peak ground accelerations 0.50g, 0.70g and 0.75g, respectively.

The rehabilitated building was able to sustain an earthquake with a peak ground acceleration about 4 times greater than the original building. However, by comparing the maximum roof displacements with the pushover curve shown in figure 6, it is evident that the behaviour of the rehabilitated building was not ductile which is expected because of the use of strong lateral load elements as structural walls.

Envelopes of lateral displacement and interstorey drift

The envelopes of maximum displacements and interstorey drifts for the existing frame are shown in figure 10a and 11a and those for the rehabilitated frame are shown in figures 10b and 11b. For the existing frame, the building response was in the first mode till failure. The interstorey drift is higher at the first floor than the second than the third floor. This indicates that damage is decreasing towards the top of the building. Considering the rehabilitated frame, the behaviour was mainly in the first mode except near collapse, as the effect of higher modes appeared. This could be due to a major damage in the first floor.

Damage to the three-storey building due to El Centro record

Figure 12a shows the damage to the building when subjected to the ground motion record. For peak ground acceleration up to 0.10g, there was no damage. Some of the elements yielded but none of them reached the strength degradation part. According to this definition, the building is still in the repairable phase and damage is minor. For the case of PGA of 0.15g, bond slip failure occurred at the base of the two interior columns. The damage at this stage will be more difficult to repair. For peak ground acceleration of 0.20g, extensive damage and collapse of the building occurred before the completion of the earthquake record. It is observed that beam-column joint shear failure occurred in five of the joints. That is different from the case of pushover analysis where there was no identified beam-column joint shear failure. This is due to the fact that the shear rigidities of the joints have significantly deteriorated due to the cyclic load application. A behaviour which can not be captured by the pushover analysis. This deterioration combined with deterioration in steel and concrete elements due to the cyclic behaviour resulted in the limited ductility that appeared in the dynamic analysis.

Figure 12b shows the damage occurred after the completion of the earthquake record. For peak ground acceleration up to 0.50g, there was no damage. Some of the elements yielded but none of them reached the strength degradation part. This means that the building is still in the repairable phase. Considering peak ground acceleration of 0.70g, bond slip failure and concrete crushing occurred in the external columns. The damage at this stage will be more difficult to repair. For peak ground acceleration of 0.75g, collapse of the building occurred before the completion of the earthquake record and as can be seen in figure 12b, major damage was detected. It is noticeable that beam-column joint shear failure occurred in two of the joints and shear failure occurred in the first story of the shear wall. That is different than the results from the pushover analysis where there was no shear failure.

SUMMARY AND CONCLUSIONS

Results from the pushover analysis on the existing three-storey frame indicated that the failure mode is mainly due to bond slip failure. There was no beam-column joint shear failures. This means that the joint capacities are sufficient to transmit the shear forces that were applied to it without failure. It should be noted that the shear forces on the joints was low due to bond slip failure. The results demonstrate the importance of including all potential modes of failure due to concrete crushing, bond slip and beam-column joint shear in the seismic assessment of structures. This is particularly important in the analysis of existing buildings with recognized inadequate lateral load resistance and nonductile reinforcement detailing. In general, a reasonable estimate of the lateral load carrying capacity and the failure mode of the building can be obtained using the pushover analysis.

Time history analysis of the original frame shows that it has very limited ductility and that a brittle failure is expected. The time history analysis is required to obtain an estimate of the ductility of the building. The pushover analysis does not give a good estimate of the building ductility because of the effect of the cyclic loading on the stiffness and strength of individual elements.

Shear failures were observed during time history analysis. This was mainly due to the degrading cyclic stiffness. In order to assess the behaviour of existing building and determine their failure mechanism, time history analysis is needed.

The designed rehabilitation system increased the ultimate strength of the building four times than the original building. However, it did not affect its ductility due to the shear failure of the wall.

Finally, the presented results are based on a limited number of analyses on a specific frame. To attempt to establish general conclusions on the behaviour of gravity load designed frames, a more comprehensive study of several frame designs subjected to different ground motion records is necessary.

REFERENCES

- Abouelfath, H., 1998, "Rehabilitation of Nonductile Reinforced Concrete Buildings Using Steel Systems", Ph.D. thesis, McMaster University, Hamilton, Ontario, Canada.
- ACI, 1963, "Building Code requirements for Reinforced Concrete", American Concrete Institute Standard 318- 63, Detroit, Michigan.
- Chung, Y.S., Meyer, C. and Massanobu, S., 1989, "Modeling of Concrete damage", ACI Structural Journal, Vol. 86, pp. 259-271.
- CSA CAN3-A23.3, 1994, "Design of Concrete Structures for Buildings", Canadian Standards Association, Rexdale, Ontario.
- Ghobarah, A. and Youssef, M., 1999, "Modeling of Reinforced Concrete Structural Walls", Engineering Structures, Vol. 21, No. 10, pp. 912-923.
- Ghobarah, A., 1998, "Seismic Assessment of Existing RC Structures", Progress in Structural Engineering and Materials, 2(1).
- Miramontes, D., Merabet, O. and Reynouard, J.M., 1996, "Beam Global Model for the Seismic Analysis of RC Frames", Earthquake Engineering and Structural Dynamics, Vol. 25, pp. 671-688.
- Park, Y.J., Reinhorn, A.M. and Kunnath, S.K., 1987, "IDARC: Inelastic Damage Analysis of Reinforced Concrete Frame - Shear - Wall Structures", Technical Report NCEER-87-0008, State University of New York at Buffalo, Buffalo, NY.
- Youssef, M. and Ghobarah, A., 1998, "Modeling of Existing RC Buildings", Eighth International Colloquium on Structural and Geotechnical Engineering, Ain Shams University, Cairo, Egypt, vol. 2, pp. 42-51.
- Youssef, M. and Ghobarah, A., 1999, "Strength Deterioration due to Bond Slip and Concrete Crushing in Modeling of RC Members", ACI Structural Journal (in press).

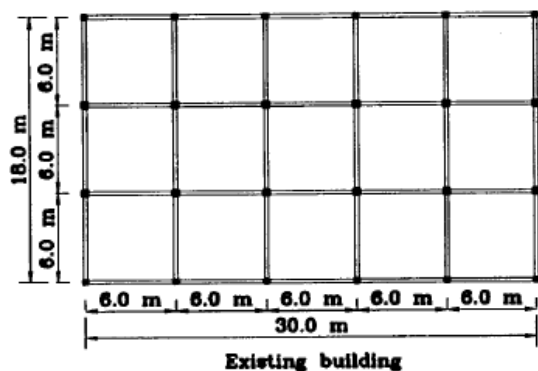

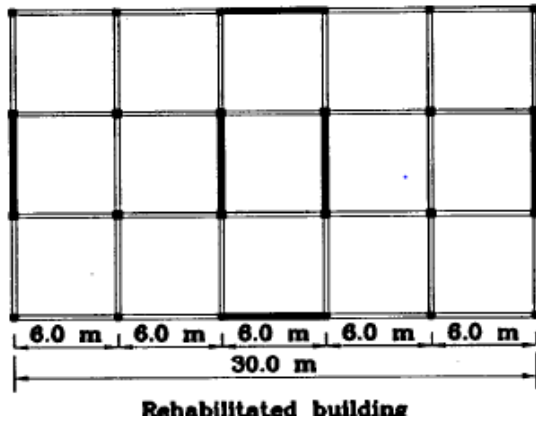

Figure 1 Typical floor plan for the three-storey building before and after rehabilitation

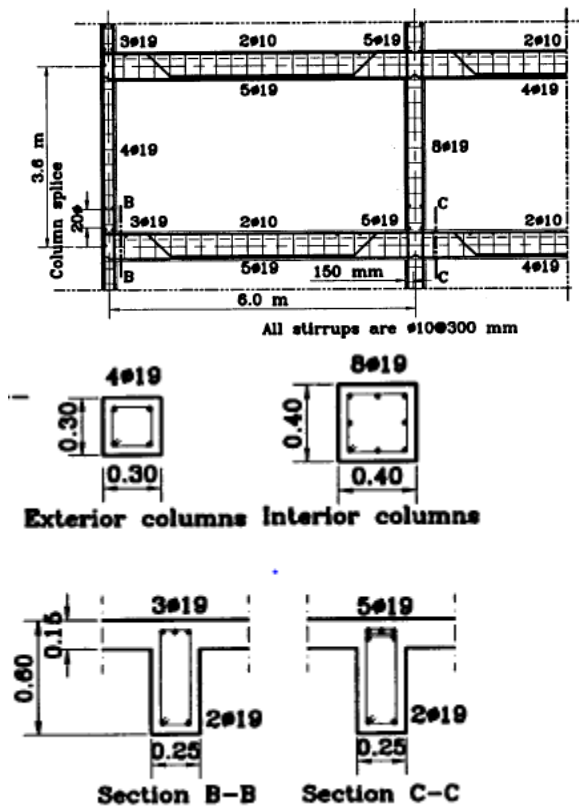

Figure 2 Reinforcement detail for the three storey frame

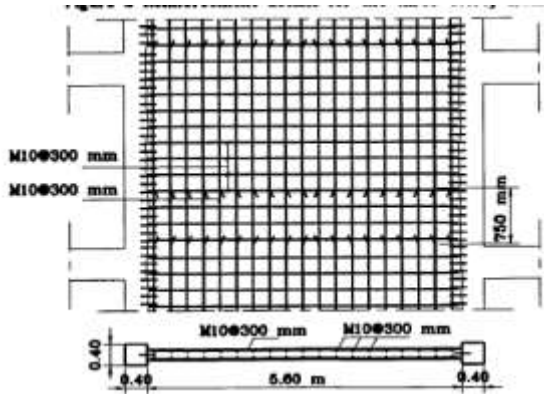
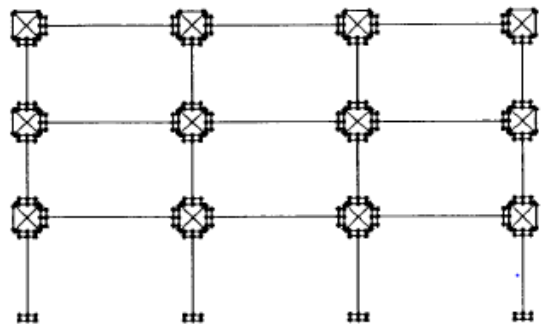
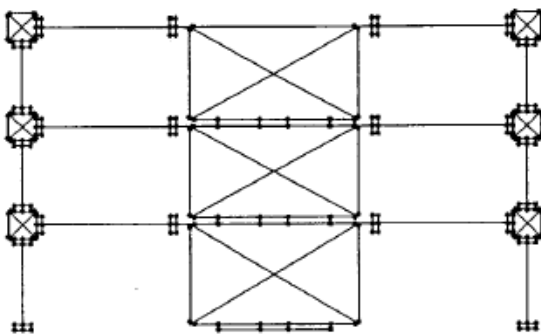

Figure 3 Details of RC walls used for rehabilitation



Existing frame



Rehabilitated frame

Figure 4 Computer model for the three storey building and after rehabilitation

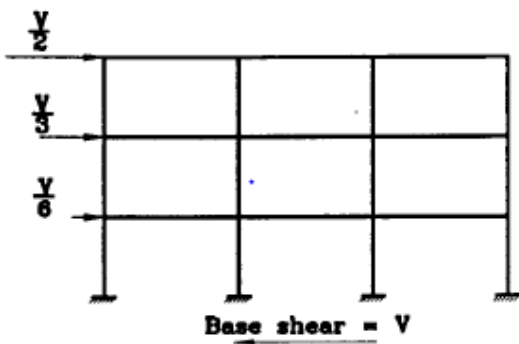

Figure 5 lateral load distribution for pushover analysis.

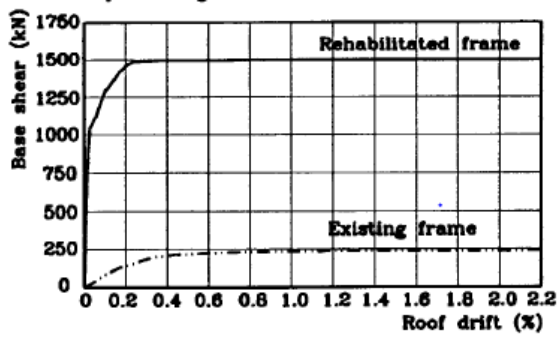

Figure 6 Base shear-roof drift relationship from pushover analysis.

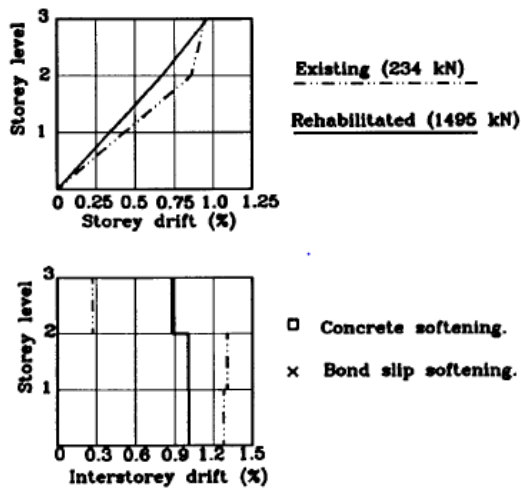

Figure 7 Storey drift and interstorey drift due to pushover analysis

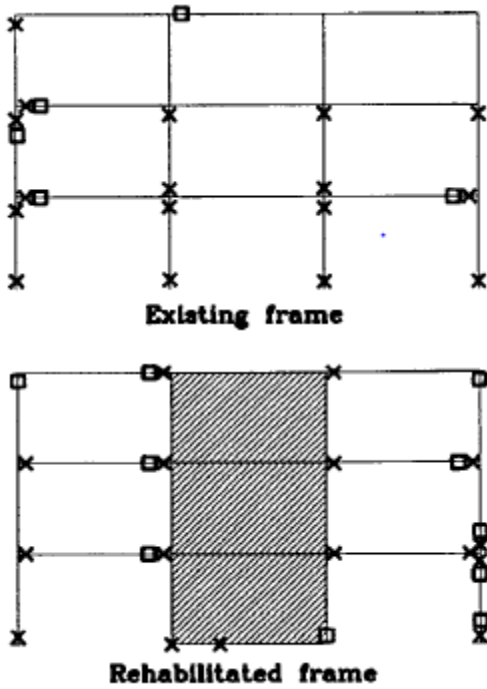
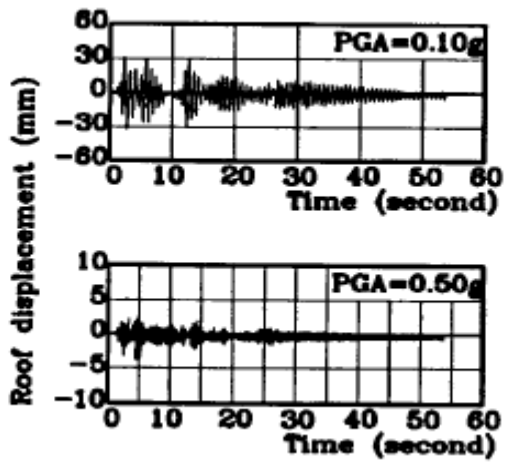

Figure 8 Failure mechanism from the pushover analysis.



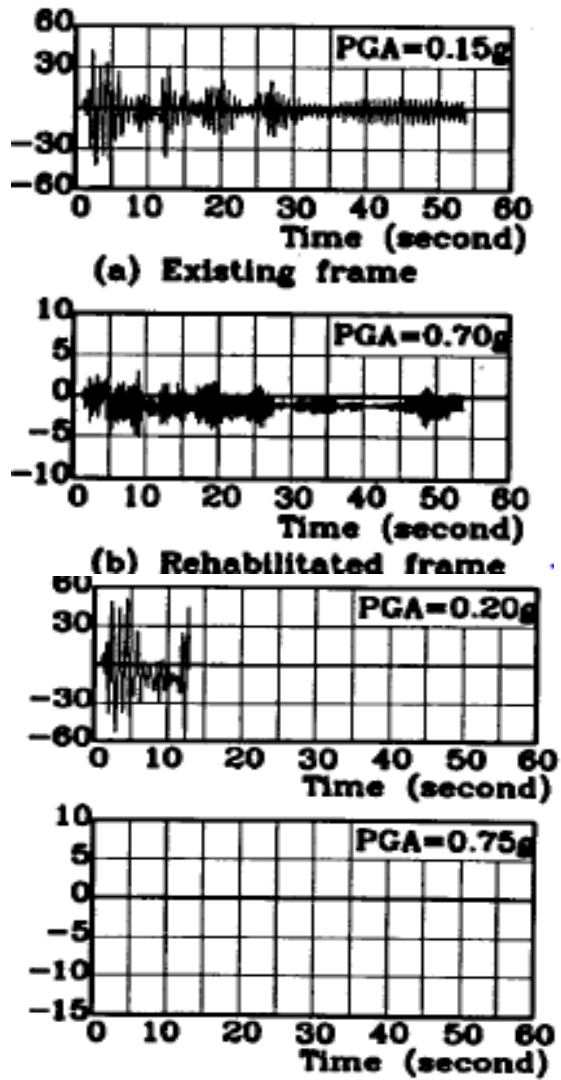
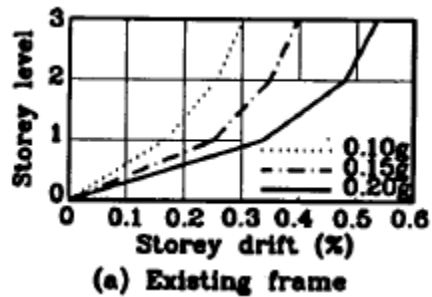

Figure 9 Roof displacement time histories for the three storey building before and after rehabilitation due to centro record.



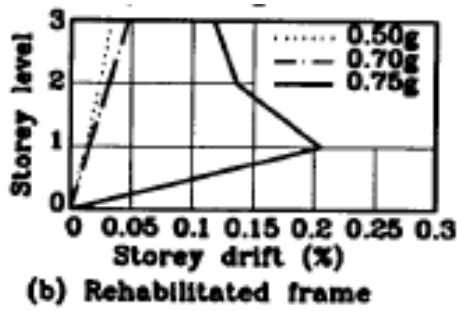

Figure 10 maximum storey drifts due to EI centro record.

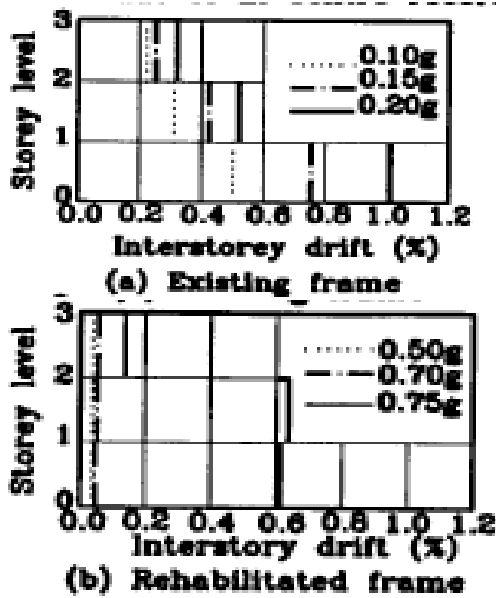
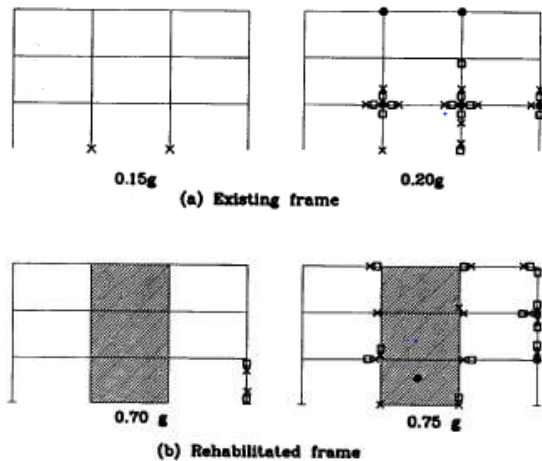

Figure 11 Maximum interstorey drifts due to EI centro record.



- Concrete softening.
- * Bond slip softening
- Shear failure in a beam-column joint or in a RC wall.

Figure 12 Damage to the three storey building due to EI centro record scaled to the shown values.